



SAFEMASTER PRO

The configurable safety system
– versatile and extendable

DOLD 
Our experience. Your safety.

The modular safety system: Safe flexibility

You may know this situation: The larger the plant and the more complex the safety requirements the higher the number of safety devices to be monitored. In addition, logic links need to be considered, e.g. for starting and shutting down individual system sections.

The solution: DOLD's new modular and configurable safety system SAFEMASTER PRO.

SAFEMASTER PRO monitors all the safety circuits on your machines and systems - in an easy, flexible and reliable manner. The number of inputs and outputs of the central control module can be increased by adding extension modules at any time. So you have the flexibility to adjust the SAFEMASTER PRO system to your relevant application.

This TÜV-certified system is easily and quickly configured via a PC using the free SAFEMASTER PRO Designer software: Select the safety functions, assign the inputs and outputs and „wire“ them via the drag, drop and click to connect graphics. Then, transfer the tested safety logic to the safety module via the USB cable. Done!

Your benefits at a glance:

- ▶ For safety applications up to PLe / Cat. 4 and SIL 3
- ▶ TÜV-certified hardware and software
- ▶ Configuration instead of wiring using the free SAFEMASTER PRO Designer software
- ▶ Easy engineering utilizing Drag & Drop with the graphic configuration software
- ▶ Time-saving and cost-effective commissioning, quick installation thanks to simple module snapping onto the DIN-rail (DOLD IN-RAIL-BUS)
- ▶ Compact design - reduces wiring and saves a lot of space in the control cabinet
- ▶ Safe speed monitoring
- ▶ Flexible extension with safety-related I/O modules
- ▶ Comprehensive fault identification and diagnosis
- ▶ Optional memory card for easy re programming
- ▶ Multi solutions from DOLD – one-stop offering

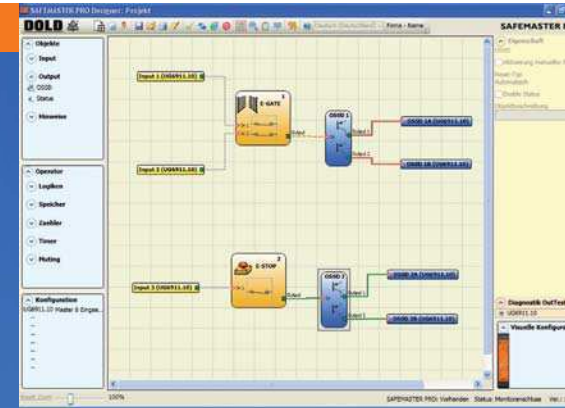

Configure this TÜV-certified system easily and quickly using the free SAFEMASTER PRO Designer software.

SAFEMASTER PRO: also as a stand-alone solution

Even in its minimum configuration a performance miracle.

Already with the control module as stand-alone unit, you can perform many applications. With 8 safety-related inputs, 2 safety-related two-channel outputs and 4 test outputs for optional cross fault monitoring you have - depending on requirements - the perfect solution for a variety of tasks. But its full power comes into effect as a master for modular extensions. It can be configured from a PC via a Mini USB port. Plus its compact design with only 22.5 mm width saves a lot of space in the enclosure and reduces wiring work.

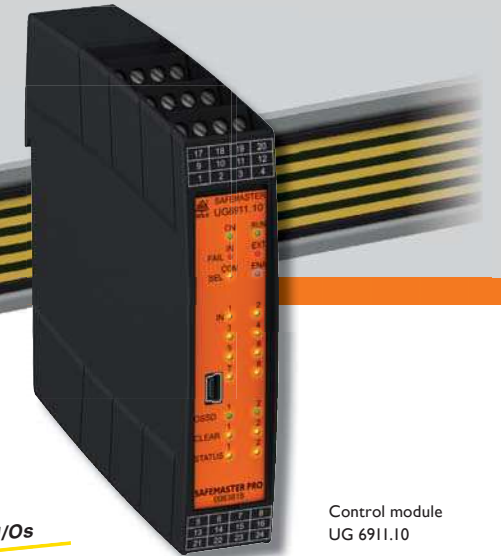

Control module
UG 6911.10

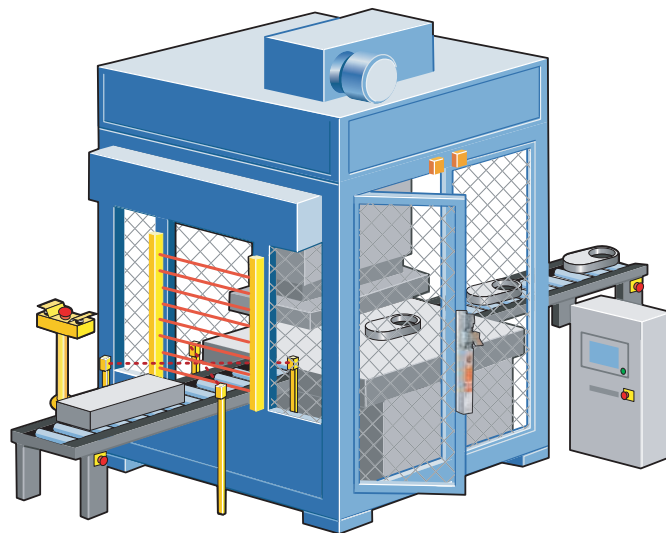

- Emergency stop/off
- Two-hand
- Motor control
- Guard doors
- Safety mats / bars
- Light barriers
- Photocells
- Key-operated switches
- Speed monitoring

Expandable with safe, remote I/Os



In addition to the control module, a maximum of 14 extension modules can be connected (plus relay output modules for more potential-free contacts). Maximum configuration: 128 safe inputs and 16 safety-related two-channel semiconductor outputs (OSSD). Via bus extend the safety I/Os can be located in larger distance to each other.

Your safety: easily configured

Configure this TÜV-certified system easily and quickly using the free SAFEMASTER PRO Designer software

With SAFEMASTER PRO Designer, DOLD provides you an easy-to-use Windows® tool allowing you to configure the system in three easy steps by Drag & Drop in a time-saving and cost-effective manner.

Then, you can carry out the integrated functional test to promptly detect any configuration errors. This prevents dangerous situations developing and it saves time in the engineering phase.

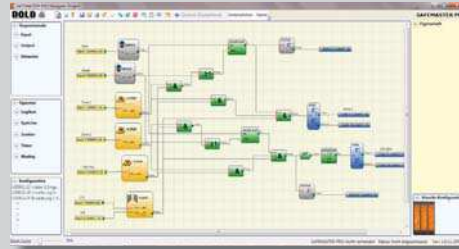

Configure first, „wire“ then test – using SAFEMASTER PRO Designer.

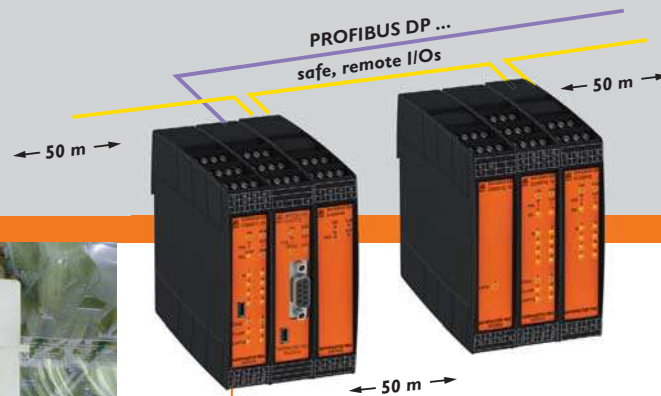

Remote, safe!
Up to 6 bus extender allows a remote of safe I/Os with a large distance.



Easy device configuration in only 3 steps:

The memory card allows an easy transfer of the configuration data to further systems (cloning).



Transfer via USB

- 1** Select and configure safety functions.
- 2** Assign the inputs and outputs and "wire" them conveniently from the PC.
- 3** Test the safety logic and transfer it to the module via a USB cable. – Done!



Many functional elements ...

All functions under control

SAFEMASTER PRO Designer reduces the engineering effort and provides fast results:

As all elements and functions can be easily combined to meet your specific safety concept using Drag & Drop functions.

And during the operation, the software ensures reliable monitoring, quick diagnosis and fast fault localisation - for the highest level of machinery availability.

Thanks to its graphic user interface, SAFEMASTER PRO Designer can be intuitively operated. All inputs and outputs can be selected freely and linked easily by logic functions. Predefined functional blocks and menus allow a smooth configuration. This single software product allows you to address Safety automation tasks - from simple to complex systems.

Input elements



Output elements



Functional and logic elements

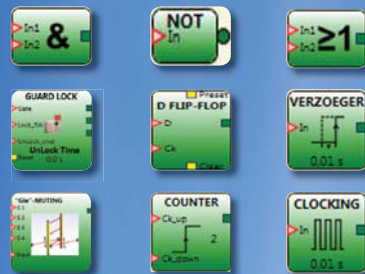

Selection of functional elements of the configuration software SAFEMASTER PRO Designer – a software for all safety-related applications.

... for convenient engineering – with diagnostic testing

Modul	Block	Typ	INPUT	Status	Diagnostik Eingänge	Modul	DSSD	Status	Diagnostik DSSD	Modul	Status	Status	Output	Diag. Out
UG6911.10	1	E-Gate	IN1	OFF	input nicht wiederhergestellt	UG6911.10	OSSD1	OFF			X		UG6911.10 F1	
			IN2								X		UG6911.10 F2	
											X		UG6911.10 F3	
											X		UG6911.10 F4	

Comprehensive diagnostic options

Once the configuration has been completed and the configuration data transferred from the laptop to the control module, the current device status can be viewed graphically in real time or in text form.

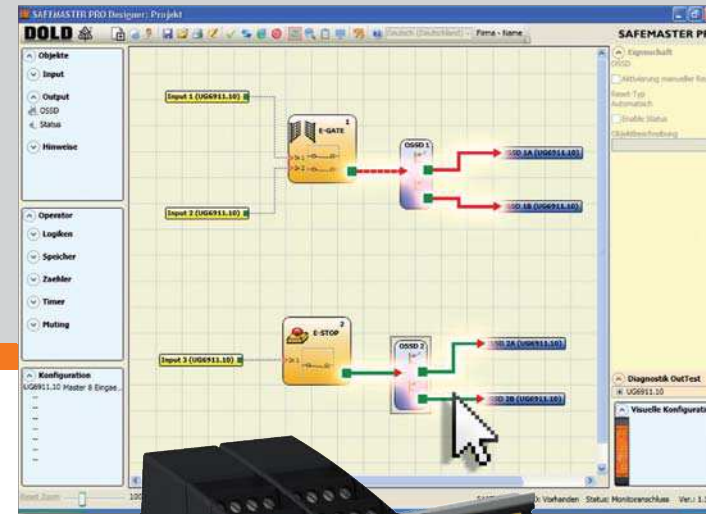

Device status in text form (above) or as graphic (below).

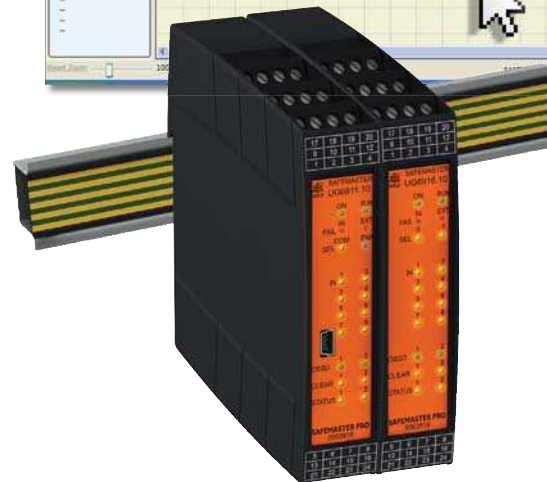

Flexible, versatile, extendable: the system components

Upgradable solutions from a single source.

With the control module as a basis, you can combine further modular system components to implement complex solutions for safety-related and standard control functions. In doing so, I/O extension modules, gateways and contact extensions are easily connected via the DOLD IN-RAIL-BUS by simply snapping them on the rail. Then, you can configure the system using the free SAFEMASTER PRO Designer software.

In this way, you can create a variety of control functions within a single system - from the most simple machine up to highly complex solutions.

Up to 14 extension modules can be connected in addition to the control module (plus relay output modules). 128 safe inputs and 16 safety-related two-channel semiconductor outputs (OSSD) as a maximum.

The bus extender UG 6918 allows to divide the system into 6 groups that can be mounted in some distance to each other.



More efficiency

SAFEMASTER PRO saves time and money in all engineering phases.

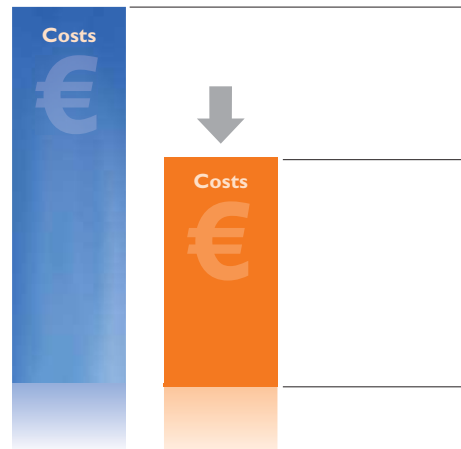

Create your individual safety system here.

Highest level of safety for all industries

- Machinery and plant
- Automation
- Transport and materials handling systems
- Paper and printing
- Food
- Rubber and plastics
- Automotive
- Forming
- Recycling
- Packaging machines
- Mechanical engineering
- Mining and metal processing
- Chemical and pharmaceutical industry
- Mountain railways and ski lifts

... and wherever safety has top priority. We cover your industry as well!

Our experience. Your safety – You too can make your machine or system substantially safer.



Type name	Device type	Performance Level (PL)* as per EN ISO 13849-1	Safety Integrity Level (SIL) CL* as per IEC 62061	Categorie (Cat)* as per EN 954-1	Safety inputs	Outputs				Art. no.
						Semiconductor		Relay		
					⊕	⊖	⊕	⊖		
UG 6911.10	Control module	e	3	4	8	2	2	-	-	0063818
UG 6916.10	Safe I/O module	e	3	4	8	2	2	-	-	0063819
UG 6913.08	Safe input module	e	3	4	8	-	-	-	-	0063820
UG 6913.12	Safe input module	e	3	4	12	-	-	-	-	0064865
UG 6913.16	Safe input module	e	3	4	16	-	-	-	-	0063821
UG 6912.02	Safe output module OSSD	e	3	4	-	2	2	-	-	0063822
UG 6912.04	Safe output module OSSD	e	3	4	-	4	4	-	-	0063823
UG 6912.14	Safe output module relay	e	3	4	-	-	-	1 x 2	1 x 1	0063824
UG 6912.28	Safe output module relay	e	3	4	-	-	-	2 x 2	2 x 1	0063825
UG 6914.04	Safe output module relay	e	3	4	-	-	8 ¹⁾	2 x 2	-	0065990
UG 6951	Fieldbus module CANopen	-	-	-	-	-	-	-	-	0063828
UG 6952	Fieldbus module PROFIBUS-DP	-	-	-	-	-	-	-	-	0063826
UG 6954	Fieldbus module PROFINET	-	-	-	-	-	-	-	-	0064861
UG 6955	Fieldbus module Ethernet/IP	-	-	-	-	-	-	-	-	0064862
UG 6956	Fieldbus module EtherCAT	-	-	-	-	-	-	-	-	0064863
UG 6957	Fieldbus module USB	-	-	-	-	-	-	-	-	0064864
UG 6918	Bus extender module	e	3	4	-	-	-	-	-	0064866

*) Value that can be reached as a maximum depending on the application, e. g. number of outputs. 1) Also available without solid-state output

Safe drive monitoring in a system

Speed monitoring module for 1 to 2 axes

Safe Motion Monitoring

The safe speed monitoring modules for the modular and configurable SAFEMASTER PRO safety system, enable safe drive monitoring in both automatic operation and set-up operation. The speed monitoring modules provide an increase in productivity and safety for the operating staff thanks to the combination of safe speed and standstill monitoring. The safety functions per IEC 61800-5-2 can be quickly and simply realised through the use of these modules.

There are modules for the safe monitoring of 1-axis or 2-axes and the monitoring can be implemented either via encoders or proximity sensors.

The new safe speed monitoring modules for SAFEMASTER PRO can be quickly and simply configured by means of the free SAFEMASTER PRO Designer software.

Technical features UG 6917

- ▶ Speed monitoring module for 1 to 2 axes
- ▶ Terminal blocks for connecting 2 proximity sensors
- ▶ Available with 0, 1 or 2 RJ45 sockets for connecting encoders (TTL, HTL, sin/cos)
- ▶ Speed pre-selection, with or without direction monitoring. Up to 4 speed thresholds can be configured.
- ▶ Speed window monitoring
- ▶ Standstill monitoring
- ▶ For rotational or linear movements
- ▶ For simple expansion of SAFEMASTER PRO via DIN rail bus (IN-RAIL-BUS)
- ▶ For safety applications up to PL e / cat. 4 or SIL 3
- ▶ Status LEDs for comprehensive diagnostics
- ▶ Installation width: 22.5 mm

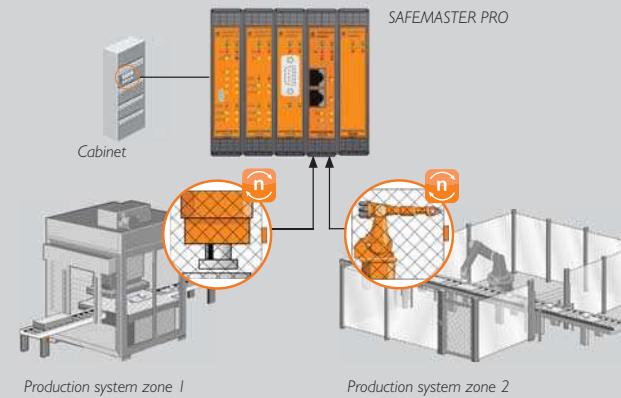

Application example

The application example shows the safety system SAFEMASTER PRO with the speed monitoring expansion. In this example, a speed module safely monitors 2 axes of a production system. The speed is sensed by encoders but can also be detected with proximity sensors.

The speed monitoring can be implemented in automatic operation, in set-up operation or both. For example, this allows one zone of a production system to be in maintenance mode whilst the second zone remains in operation.

Different module combinations enable safety level PL e / cat. 4 to be achieved or up to 12 axes to be monitored.

Safe speed monitoring with the new SAFEMASTER PRO expansion modules. Monitoring of 2 axes by means of encoders (alternatively with proximity sensors). Simple configuration with the free SAFEMASTER PRO Designer software tool.

Safety functions

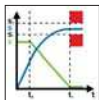

Safe Operating Stop (SOS)



Safe Speed Range (SSR)



Safely Limited Speed (SLS)



Safe Door Locking (SDL)



Safe Torque Off (STO)

Expand your individual safety system with speed monitoring.



Type	Device type	Performance Level (PL)* per EN ISO 13849-1	Safety Integrity Level (SIL) CL* per IEC 62061	Signal generator			Art. no.	
				Proximity sensor	Encoder			
					TTL	HTL		sin/cos
UG 6917/002	Speed monitoring module	e	3	2	-	-	-	0066059
UG 6917/102	Speed monitoring module	e	3	2	1	-	-	0066060
UG 6917/202	Speed monitoring module	e	3	2	-	1	-	0066062
UG 6917/302	Speed monitoring module	e	3	2	-	-	1	0066064
UG 6917/112	Speed monitoring module	e	3	2	2	-	-	0066061
UG 6917/222	Speed monitoring module	e	3	2	-	2	-	0066063
UG 6917/332	Speed monitoring module	e	3	2	-	-	2	0065992

*) Max. achievable value depends on the application

The system components in detail

Versatile and flexible

With SAFEMASTER PRO, you can monitor safety sensors, light curtain signals, photocells, emergency stop devices, safety mats, two-hand transmitters or magnetic and mechanical safety switches such as SAFEMASTER STS.



Control module

UG 6911.10 | Art. no.: 0063818

Controls emergency stop/off devices, two-hand circuits, guard doors, safety mats, light curtains, photocells, foot switches, key-operated switches, selector switches, standard sensors, standard switches, etc.

- ▶ 8 safe single-channel inputs, can be pair connected
- ▶ 2 safe two-channel outputs (OSSD), separately controllable
- ▶ 4 test outputs for sensor monitoring
- ▶ Integrated feedback loops for the two safe outputs with separately configurable start conditions
- ▶ Configurable with SAFEMASTER PRO Designer from a PC via Mini USB port
- ▶ Optional memory card for the transfer of configuration data (cloning)
- ▶ Can also be used as a stand-alone unit
- ▶ Signalling outputs, status LEDs and field bus connection via diagnostic modules for comprehensive diagnosis
- ▶ Width: 22.5 mm

Input/output module

UG 6916.10 | Art. no.: 0063819

- ▶ 8 safe single-channel inputs, can be pair connected
- ▶ 2 safe two-channel semiconductor outputs (OSSD), separately controllable
- ▶ Integrated feedback loops for the two safe outputs with separately configurable start conditions
- ▶ 4 test outputs for sensor monitoring
- ▶ For an easy extension of SAFEMASTER PRO via rail bus (IN-RAIL-BUS)
- ▶ Status LEDs and 2 programmable signalling outputs for comprehensive diagnosis
- ▶ Width: 22.5 mm

Input modules

UG 6913.08 | Art. no.: 0063820

UG 6913.12 | Art. no.: 0064865

UG 6913.16 | Art. no.: 0063821

- ▶ UG 6913.08: 8 safe single-channel inputs, can be pair connected
- ▶ 4 test outputs for sensor monitoring
- ▶ UG 6913.12: 12 safe single-channel inputs, can be pair connected
- ▶ 8 test outputs for sensor monitoring
- ▶ UG 6913.16: 16 safe single-channel inputs, can be pair connected
- ▶ 4 test outputs for sensor monitoring
- ▶ For easy extension of SAFEMASTER PRO via rail bus (IN-RAIL-BUS)
- ▶ Status LEDs and 2 programmable signalling outputs for comprehensive diagnosis
- ▶ Width: 22.5 mm

Output modules OSSD

UG 6912.02 | Art. no.: 0063822

UG 6912.04 | Art. no.: 0063823

- ▶ UG 6912.02: 2 safe two-channel semiconductor outputs (OSSD), separately controllable
- ▶ UG 6912.04: 4 safe two-channel semiconductor outputs (OSSD), separately controllable
- ▶ For easy extension of SAFEMASTER PRO via rail bus (IN-RAIL-BUS)
- ▶ Integrated feedback loops for the 2 or 4 safe outputs with separately configurable start conditions
- ▶ Status LEDs and 2 programmable signalling outputs for comprehensive diagnosis
- ▶ Width: 22.5 mm

Relay output expansion modules

UG 6912.14 | Art. no.: 0063824

UG 6912.28 | Art. no.: 0063825

- ▶ For potential-free contact expansion of the SAFEMASTER PRO OSSDs
- ▶ UG 6912.14: 1 relay output expansion with 2 safety-oriented NO contact sets and 1 NC contact set as reporting output
- ▶ UG 6912.28: 2 relay output expansions, each with 2 safety-oriented NO contact sets and 1 NC contact set as reporting output
- ▶ Status LED for operating voltage and output

Relay output modules

UG 6914.04 | Art. no.: 0065990

- ▶ 4 independent, single-channel safety relay outputs
- ▶ UG 6914.04/008: 8 freely usable, non-secure, solid-state reporting outputs (OUT-STATUS)
- ▶ Each with 1 feedback circuit for the 2 or 4 safe outputs with individually configurable start conditions
- ▶ Status LEDs for comprehensive diagnostics

Extension module

UG 6918 | Art. no.: 0064866

(Bus extender)

- ▶ For remote of safe I/Os
- ▶ Divides the system into 6 I/O groups
- ▶ Distance between groups 50 m each
- ▶ Width: 22.5 mm

Fieldbus modules

UG 6951 (CANopen) | Art. no.: 0063828

UG 6952 (PROFIBUS DP) | Art. no.: 0063826

UG 6954 (PROFINET) | Art. no.: 0064861

UG 6955 (Ethernet/IP) | Art. no.: 0064862

UG 6956 (EtherCAT) | Art. no.: 0064863

UG 6957 (USB) | Art. no.: 0064864

- ▶ For comprehensive diagnosis and data-communication
- ▶ SAFEMASTER PRO can be integrated in existing standard (non-safe) field bus systems for visualisation purposes
- ▶ Width: 22.5 mm

SAFEMASTER PRO - Universal and expandable...

Comprehensive combination options

SAFEMASTER PRO can be ideally combined with the SAFEMASTER STS safety switch and key transfer system. This enables the speed monitoring to be implemented via the SAFEMASTER PRO module and the safety-oriented monitoring of maintenance and safety doors via SAFEMASTER STS.

Furthermore, almost any safety sensor will be suitable for connecting to the SAFEMASTER PRO safety system. From simple emergency stop buttons, safety switches, command devices and key transfer systems on to speed monitoring - almost any configuration or connection option can be implemented.



SAFEMASTER PRO

The safety system monitors safety functions such as emergency stop, safety door, light barriers, two-hand, speed monitoring and much more. With that, a system with numerous automation tasks can be realised - from the simplest machines to interlinked devices, up to highly complex solutions.

... with interlocking system

Command devices

Command devices enable safety doors to be monitored on machines and systems. They expand switch modules and solenoid locks with additional command functions in order to monitor main access points and maintenance access points for example.

Safety switches

Safety switches are used for the electrical monitoring of access points or safety doors, for example. If an access point is opened whilst the system is operating, the system is immediately switched off.

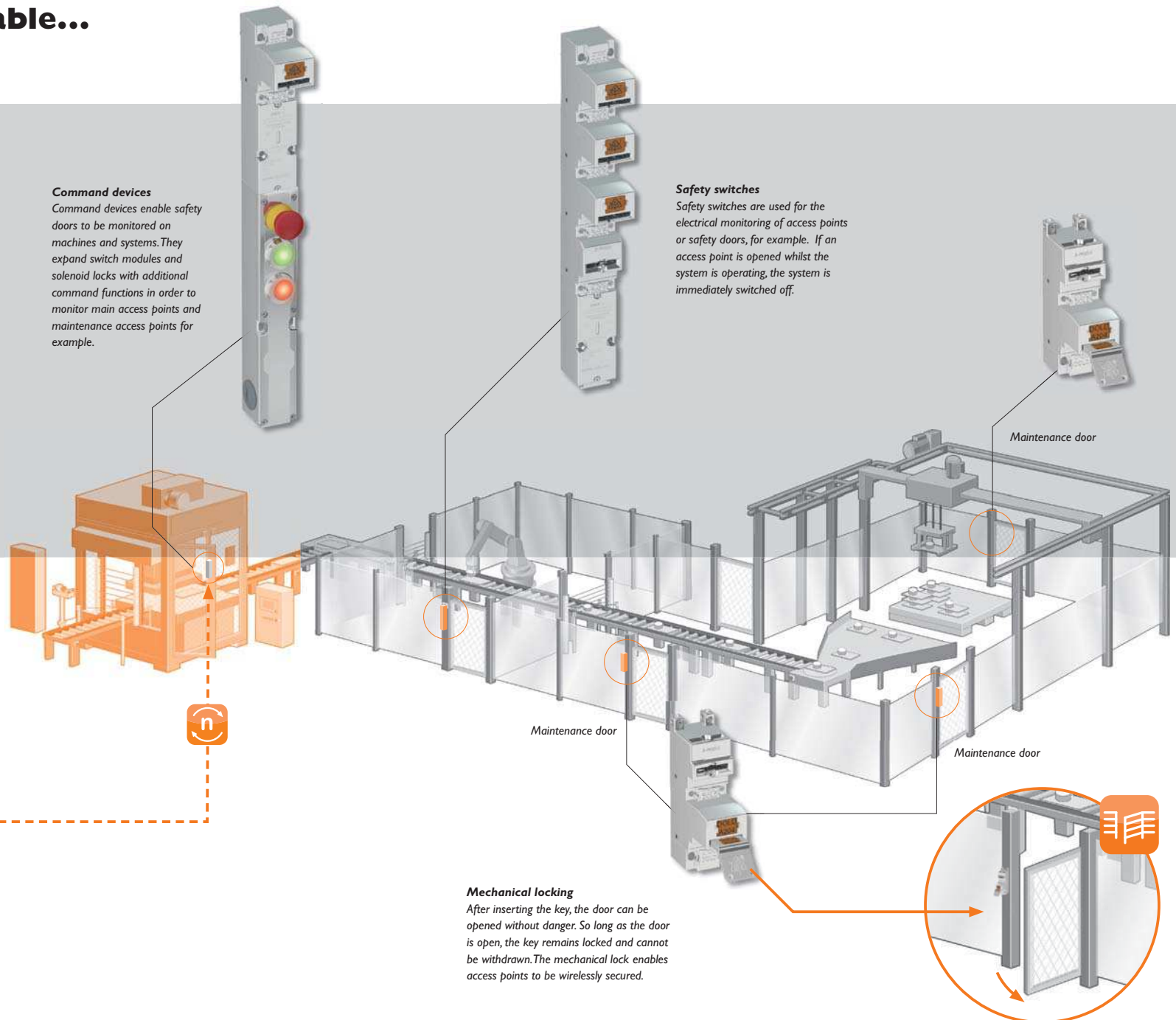

Mechanical locking

After inserting the key, the door can be opened without danger. So long as the door is open, the key remains locked and cannot be withdrawn. The mechanical lock enables access points to be wirelessly secured.

Our experience. Your safety.

Upgradable safety solutions from DOLD

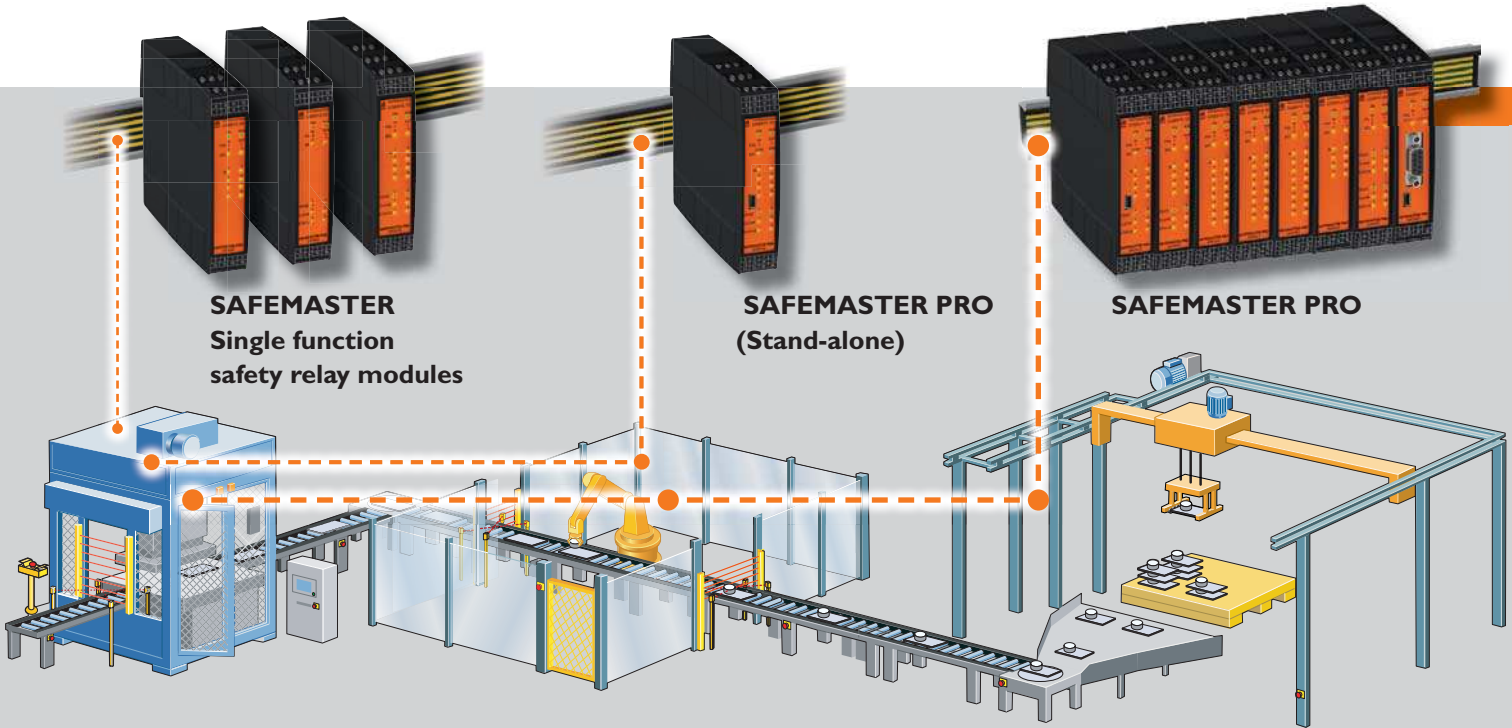

Innovative safe complete solution:



Standstill and speed monitoring



Wireless Safety Systems



Safety switch and key transfer systems

Wherever people, machinery and products must be protected against damage and an increase in productivity is required, DOLD safety relay modules have been successfully employed throughout the world for many decades.

In addition to the standard range of devices DOLD can fall back on many years of experience in developing custom tailor made solutions.

What can we do for you?

Challenge us. We look forward to finding the solution!

DOLD



E. DOLD & SÖHNE KG
P.O. Box 1251 • 78114 Furtwangen • Germany
Phone +49 7723 6540 • Fax +49 7723 654356
dold-relays@dold.com • www.dold.com